

PACKAGE DIMENSION

HS-3292A/BX

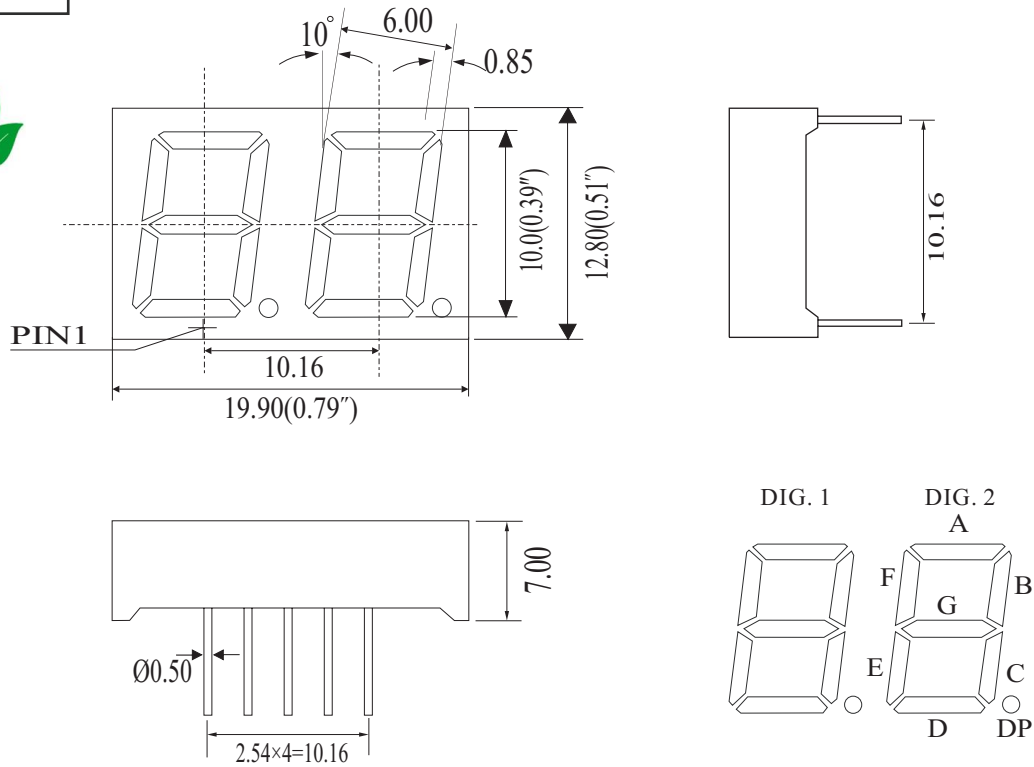

UNIT: MM(INCH) TOLERANCE: $\pm 0.25(0.01)$ "

Internal Circuit Diagram

HS-3292A

HS-3292B

