

PACKAGE DIMENSION

HS-4201E/FX

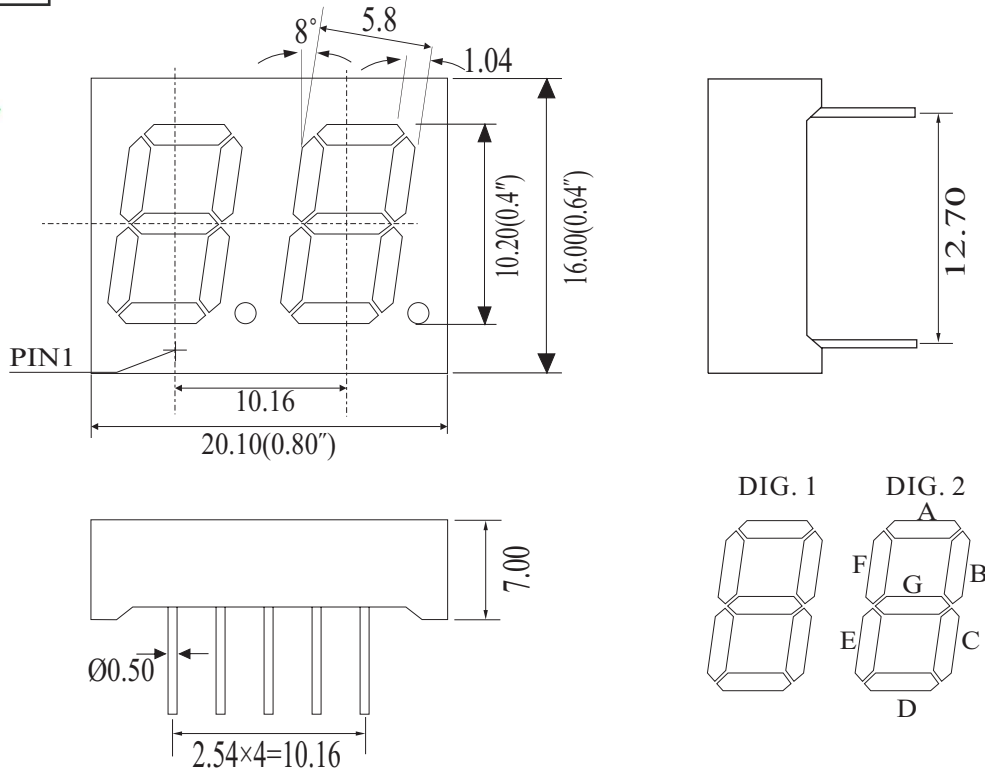

UNIT: MM(INCH) TOLERANCE: $\pm 0.25(0.01)$ "

Internal Circuit Diagram

HS-4201E

HS-4201F

